

Datasheet CXR Series

Available Distribution

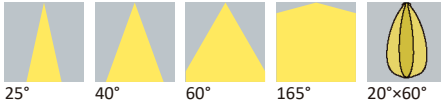

LED



Recommnd Applications

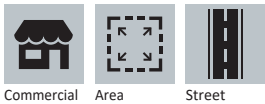

General Information

PMMA 70°C -40°C	PC 110°C -40°C	PMMA 8N HB 1.5mm RTI 90°C	PC LUX 2180T V-2 1.5mm RTI 130°C	400nm~900nm > 90%		
-----------------------	----------------------	---------------------------------	--	----------------------	--	--

- Lens Material L06: PMMA 8N / L52: PC LUX 2180T
- Operating Temperature PMMA: -40°C~+70°C / PC: -40°C~+110°C
- UL Flammability PMMA: HB / PC LUX 2180T: V-2 @1.5mm
- UL RTI Elec PMMA: 90°C / PC LUX 2180T: 130°C @1.5mm
- Light Transmission Rate 400nm~900nm > 90%
- ☑ If necessary, Clean lenses with mild soap, water and soft cloth.
- ⚠ Never use any commercial cleaning solvents on lenses, like alcohol.
- ⚠ Please handle or install lenses with wearing gloves, skin oils may damage lens or its optical characteristic.

Dimensions

Part Number	Height	LxW
LL04CR-CXR25L52	12.86	50x50
LL04CR-CXR40L52	12.99	
LL04CR-CXR60L52	12.86	
LL04CR-CXR165L52	6.68	
LL04LU-CXR2060L06	8.5	

*All dimensions are in millimeters.

Packaging Details (SPQ)

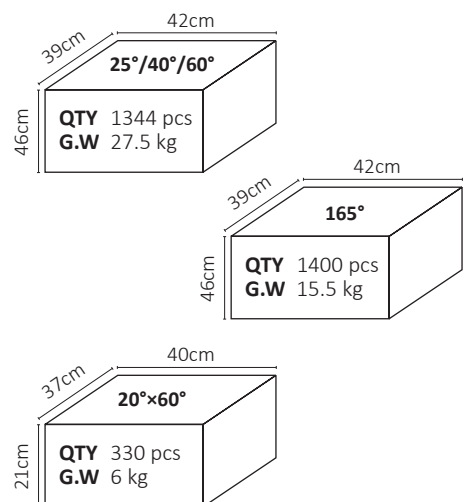

Mechanical Specification

*All dimensions are in millimeters.

Lens Dimension

LL04CR-CXRxxL52 (25°/40°/60°)

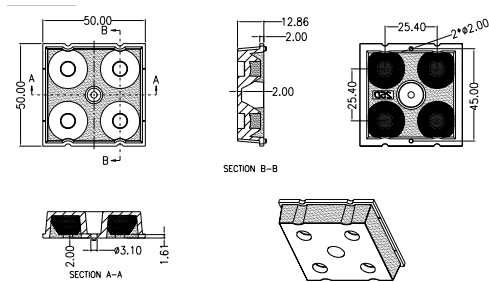

Lens Dimension

LL04CR-CXR165L52

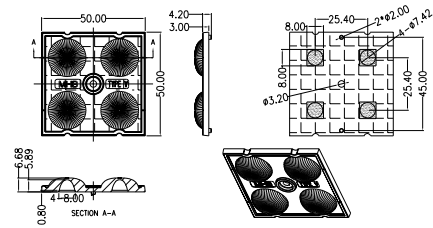

Lens Dimension

LL04LU-CXR2060L06

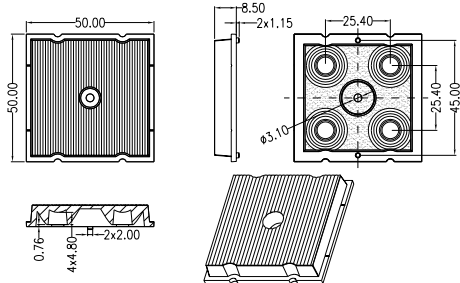

Assembly Instruction

Part No LL04CR-CXRxxL52 (25°/40°/60°)
LL04LU-CXR2060L06

Fixing Method

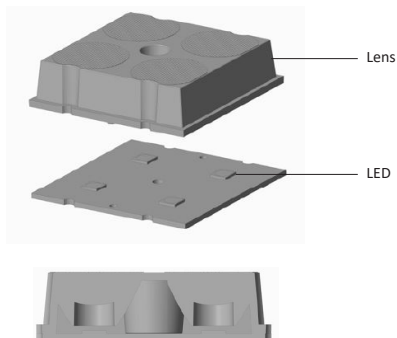

Assembly Instruction

Part No LL04CR-CXR165L52



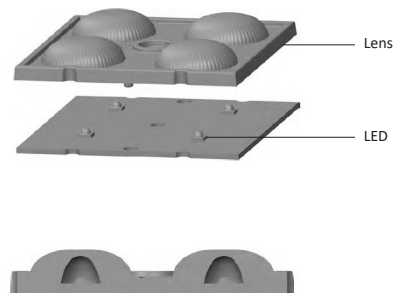



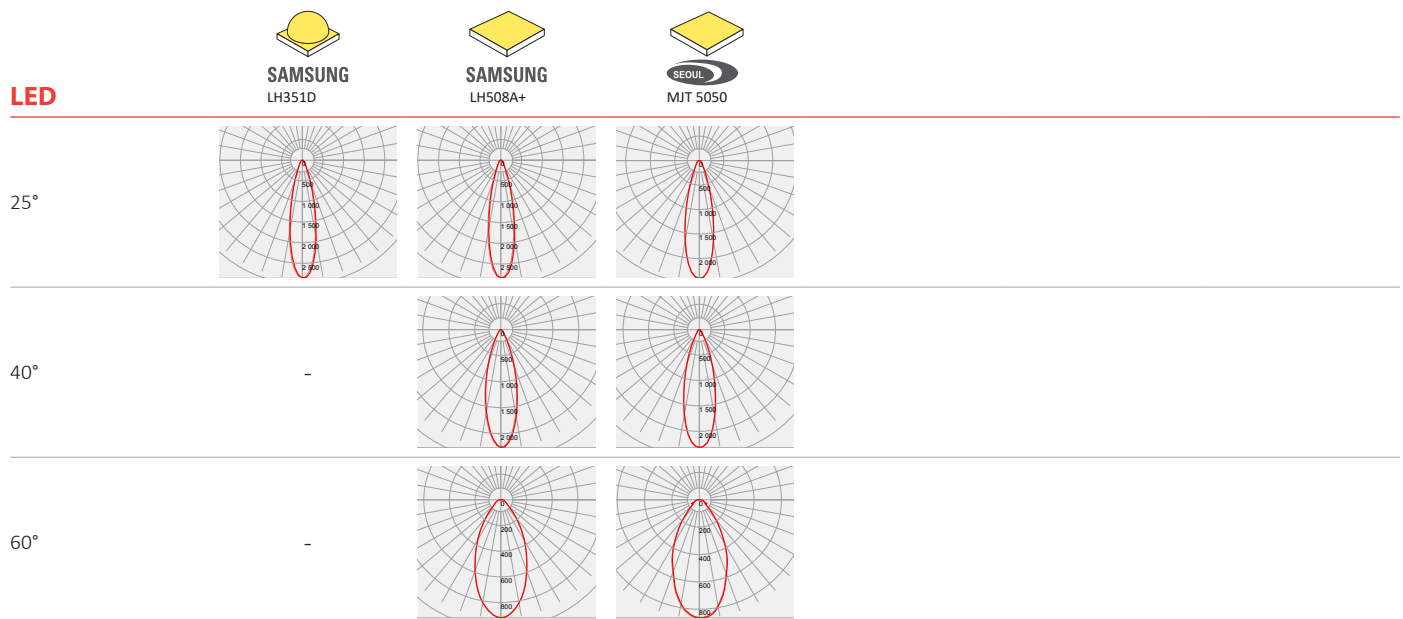
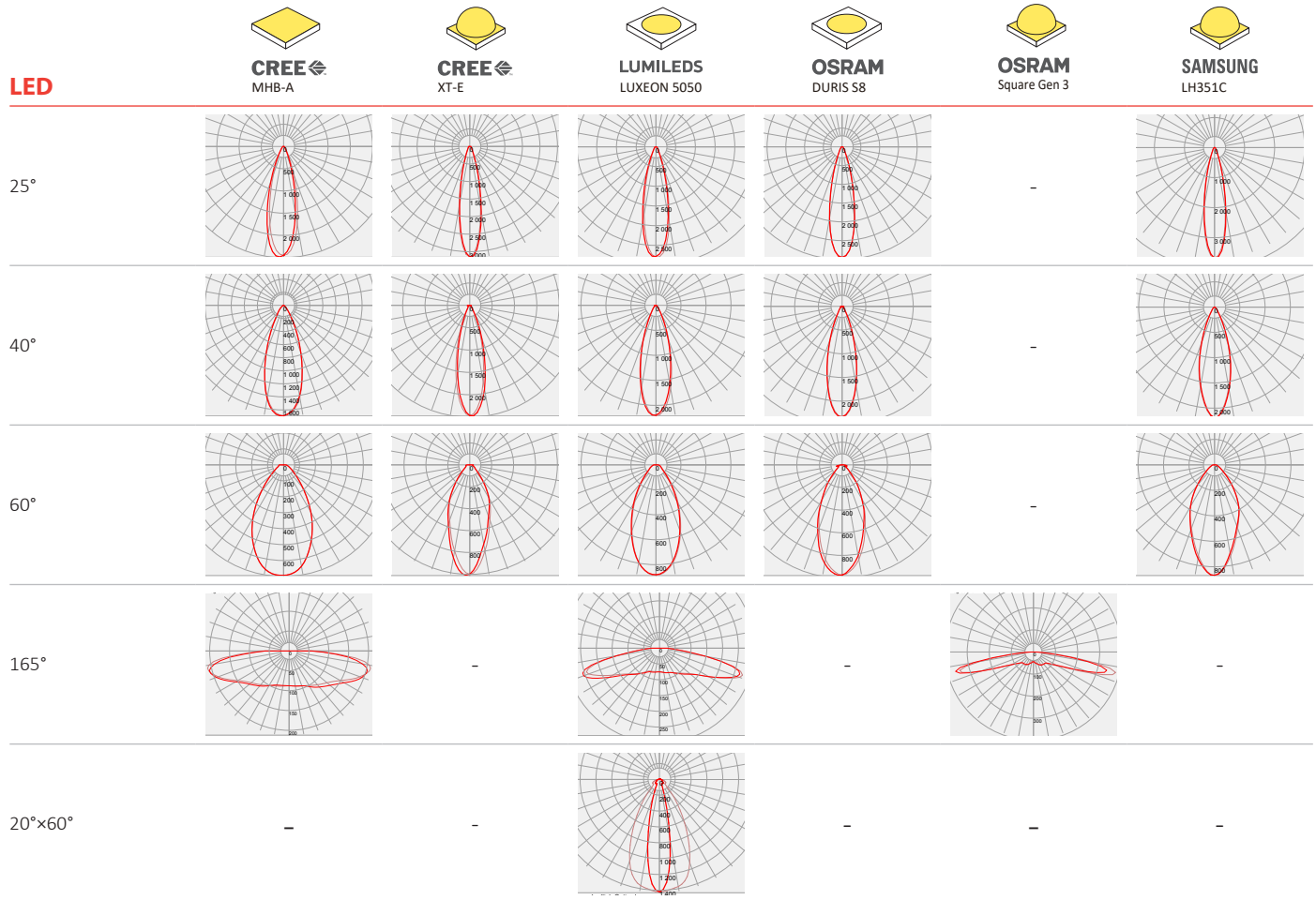

Fixing Method











Photometric Distribution



Details by LED

Part No	Accessories	LED Package Size	LED
LL04CR-CXRxxL52 LL04LU-CXR2060L06	-	3030 / 3535 / 5050	        

LED	Part No	Type	FWHM	cd / lm	IES
 CREE MHB-A	LL04CR-CXR25L52	-	28°	2.4	↓
	LL04CR-CXR40L52	-	37°	1.6	↓
	LL04CR-CXR60L52	-	61°	0.6	↓
	LL04CR-CXR165L52	V-Long	173°	0.2	↓
 CREE XT-E	LL04CR-CXR25L52	-	22°	3.1	↓
	LL04CR-CXR40L52	-	28°	2.4	↓
	LL04CR-CXR60L52	-	43°	1.0	↓
	LL04CR-CXR165L52	-	-	-	-
 LUMILEDS LUXEON 5050	LL04CR-CXR25L52	-	26°	2.8	↓
	LL04CR-CXR40L52	-	31°	2.2	↓
	LL04CR-CXR60L52	-	51°	0.8	↓
	LL04CR-CXR165L52	V-Medium	160°	0.2	↓
 OSRAM DURIS S8	LL04LU-CXR2060L06	-	22°x56°	1.4	↓
	LL04CR-CXR25L52	-	25°	2.9	↓
	LL04CR-CXR40L52	-	30°	2.3	↓
	LL04CR-CXR60L52	-	48°	0.9	↓
 OSRAM Square Gen 3	LL04CR-CXR165L52	-	-	-	-
	LL04CR-CXR25L52	-	-	-	-
	LL04CR-CXR40L52	-	-	-	-
	LL04CR-CXR60L52	-	-	-	-
 SAMSUNG LH351C	LL04CR-CXR165L52	V-Medium	163°	0.3	↓
	LL04CR-CXR25L52	-	22°	3.6	↓
	LL04CR-CXR40L52	-	32°	2.1	↓
	LL04CR-CXR60L52	-	52°	0.8	↓
 SAMSUNG LH351D	LL04CR-CXR165L52	-	-	-	-
	LL04CR-CXR25L52	-	24°	2.8	↓
	LL04CR-CXR40L52	-	-	-	-
	LL04CR-CXR60L52	-	-	-	-
 SAMSUNG LH508A+	LL04CR-CXR165L52	-	-	-	-
	LL04CR-CXR25L52	-	24°	2.8	↓
	LL04CR-CXR40L52	-	30°	2.2	↓
	LL04CR-CXR60L52	-	51°	0.9	↓
 SEOUL MJT 5050	LL04CR-CXR165L52	-	-	-	-
	LL04CR-CXR25L52	-	27°	2.4	↓
	LL04CR-CXR40L52	-	30°	2.3	↓
	LL04CR-CXR60L52	-	54°	0.8	↓

Product Nomenclature

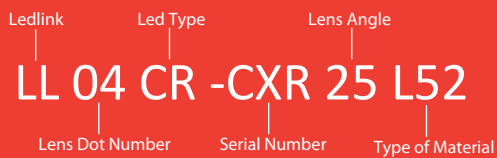

Ledlink Optics, Inc

Taiwan HQ

15F, No.655, Bannan Rd., Chung-Ho Dist.,
New Taipei City, Taiwan 235

Ledlink Optics (Dongguan) Co., Ltd

Dongguan Factory

No.5, TianKeng Industrial Dist., HengLiTown, DongGuan City,
GuangDong Province, China 523478

Ledlink Optics (Yangzhou) Co., Ltd

Yangzhou Factory

No.180, LinJiang Rd., YangZhou City, Jiangsu Province, China 225009

www.ledlink-optics.com

service@ledlink-optics.com

